

Model PD-6 operation manual (supplement for V2.20)

The PD-6 software is upgraded to V2.20 and some functions are expanded, added or changed.

Please read this supplement together with the PD-6 operation manual and other supplementary manual(s).

Table of contents

Summary of enhanced/changed/added functions	3
Change of drive names displayed on the "Select drive" screen	4
Ubit information display capability on the Normal screen	5
Change of the Setup menu item order	6
Enhancement of the "Default file name" menu item in the Setup menu	7
"False Start" menu item newly added to the Setup menu	8
"Chain Play" menu item newly added to the Setup menu	9
Changes in the "Set Gen.TC" menu item of the TC SETUP menu	10
"Set Gen Ubit" menu item newly added to the TC SETUP menu	11
Enhancement of the "Format" menu item in the UTILITY menu	12
Change in the "Pull Up/Down" function	13
Enhanced USB keyboard operation	14

Summary of enhanced/changed/added functions

By upgrading the PD-6 software to version 2.20, the following changes are made.

- 1) **Drive names displayed on the "Select drive" screen are changed.**
Drive names displayed on the "Select drive" screen which is used when you select the drive are changed. See page 4 for details.
- 2) **The new "Repro Ubit" option is added to the time display modes on the Normal screen.**
The new "Repro Ubit" option is added to the time display modes on the Normal screen, so you can see the reproduced user bit easily. See page 5 for details.
- 3) **The order of the Setup menu items is changed.**
The order of the menu items in the Setup menu is changed so that you can easily access to items you frequently use. See page 6 for details.
- 4) **The "Default file name" menu item in the Setup menu is enhanced.**
The "Default file name" menu item in the Setup menu is enhanced by adding the "Reel mode" option to the default file name mode. See page 7 for details.
- 5) **The new "False Start" menu item is added to the Setup menu.**
The new "False Start" menu item added to the Setup menu allows you to select whether deleting or keeping the file after executing False start. See page 8 for details.
- 6) **The new "Chain play" menu item is added to the Setup menu.**
The new "Chain play" menu item added to the Setup menu allows you to set the transport mode after an audio file is played back to the end. By setting this menu item appropriately, you can automatically play back audio files on a disk (or a partition) continuously. See page 9 for details.
- 7) **The "Set Gen.TC" menu item in the TC Setup menu is enhanced.**
When the TC GEN mode is set to "Free Run", the "Set Gen.TC" menu item now allows you to jam the internal realtime clock time data, in addition to the TC value editing capability. Also, the user bit setting capability when the TC GEN mode is set to "Free Run" has been deleted from the "Set Gen.TC" menu item (the user bit setting now can be done via the newly added "Set Gen Ubit" menu item in the TC Setup menu). See page 10 for details.
- 8) **The "Set Gen Ubit" menu item is added to the TC Setup menu.**
The "Gen Ubit" menu item has been deleted from the TC Setup menu. Instead, the "Set Gen Ubit" menu item is newly added to the TC Setup menu. This menu item allows you to set the user bit mode and user bit value in the same screen (in the earlier version, the user bit value setting can be made via the "Set Gen.TC" menu item). See page 11 for details.
- 9) **The "Format" menu item in the DISK UTILITY menu is enhanced.**
The "Format" menu item is used for formatting a DVD-RAM disk (or a partition of the optional internal hard disk). There are some changes in this menu item regarding the physical format on/off selection, default format mode, etc. See page 12 for details.
- 10) **The pull-up/pull-down function now works differently from the earlier version.**
With the earlier version, when the unit is running with the internal clock reference and the pull-down or pull-up function is active, the TC frame rate always changes in sync with the speed change. With the new version, the TC frame rate does not always change. See page 13 for details.
- 11) **The USB keyboard capability for controlling the unit is enhanced.**
Now you can control the unit from a USB keyboard connected to the [USB (KYBD ONLY)] port on the PD-6 more flexibly. See page 14 for details.

Change of drive names displayed on the "Select drive" screen

Drive names displayed on the "Select drive" screen which is used when you select the drive are partly changed.

To bring up the "Select drive" screen, carry out either of the following operations.

1. When the shift mode is active (the [SHIFT] indicator is lit), press the [LIGHT] key.
2. When the shift mode is inactive, press the [SETUP] key to enter the Setup menu and select the "Select drive" menu item, then press the [ENTER] key.

The "drive select" function has been added from V200. See the "Version 2.00 supplementary manual" for details about this function.

Before V2.20	From V2.20
The "Select drive" screen when no drive option is installed	
<pre> SETUP▶Select drive -- PD-6 Internal -- MAIN DVD Drive </pre>	<pre> SETUP▶Select drive -- PD-6 Internal -- iDVD[S001] </pre>
The "Select drive" screen when no drive option is installed.	
A "Select drive" screen example when the Model 9056 (Internal hard disk) is installed and the PD-6 DVD-RAM is selected	
<pre> SETUP▶Select drive -- PD-6 Internal -- MAIN DVD Drive iP01[S002]] iP02[S003]] iP03[S004]] iP04[S005]] </pre>	<pre> SETUP▶Select drive -- PD-6 Internal -- iDVD[S001]] iP01[S002]] iP02[S003]] iP03[S004]] iP04[S005]] </pre>
You can select from among the PD-6 DVD-RAM drive (iDVD) and HDD partitions (iP01 through iP27).	
A "Select drive" screen example when the EX-12 is connected and the EX-12 DVD-RAM is selected	
<pre> SETUP▶Select drive -- EX12 External -- MAIN DVD Drive EXT DVD Drive eP01[S003]] eP02[S004]] eP03[S005]] </pre>	<pre> SETUP▶Select drive -- EX12 External -- iDVD[S001]] eDVD[S002]] eP01[S003]] eP02[S004]] eP03[S005]] </pre>
You can select from among the PD-6 DVD-RAM drive (iDVD), EX-12 DVD-RAM drive (eDVD) and EX-12 hard disk partitions (iP01 through iP08).	

When the Model 9056 optional hard disk drive is installed and the EX-12 is connected to the PD-6, you can select from among the PD-6 DVD-RAM drive (iDVD), internal hard disk partitions (iP01 through iP27), the EX-12 DVD-RAM drive (eDVD) and EX-12 hard disk partitions (eP01 through eP08).

Ubit information display capability on the Normal screen

The new "Repro Ubit" option is added to the time display modes on the Normal screen. You can switch the time display mode among the following using the [TIME/DISP MODE] key.

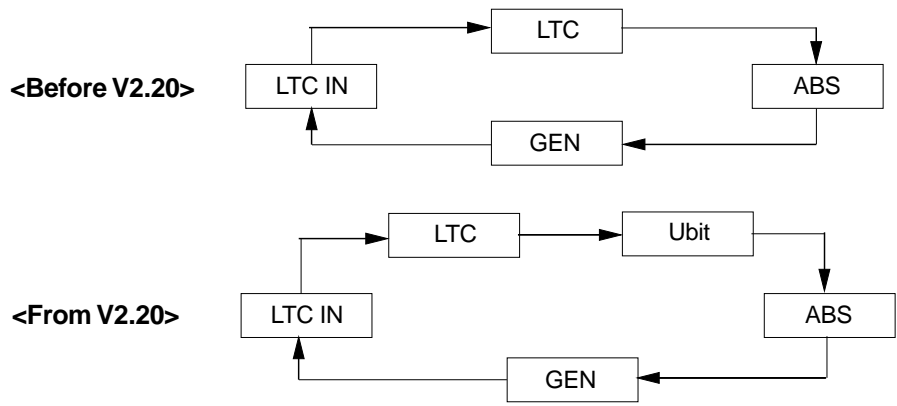

"LTC" mode example

When the unit is turned on, the LTC mode is active.

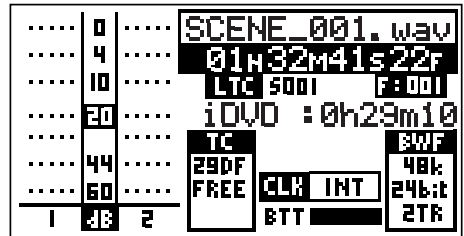

"Repro Ubit" mode example

The reproduced user bit is shown in the time display field.

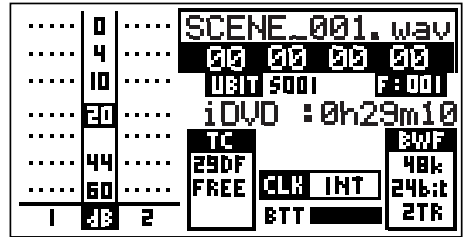

"ABS" mode example

The current ABS time is shown.

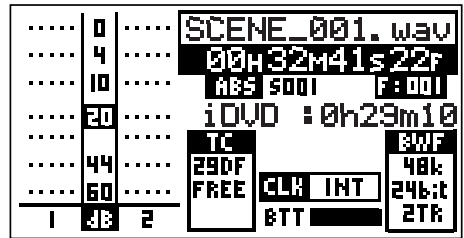

"GEN" mode example

The internal generator time is shown only when the generator mode is set to "FREE RUN" or "24H". When the generator mode is set to any other mode, "-----" is shown.

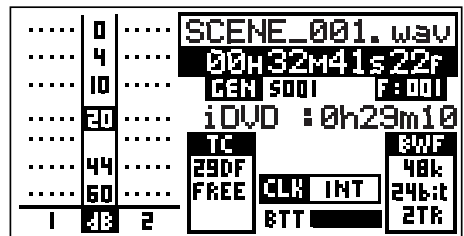

"LTC IN" mode example

The external time code value is shown. When the unit does not receive external time code, "-----" is shown.

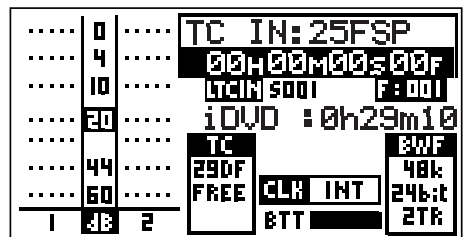

Change of the Setup menu item order

The menu items in the Setup menu screen are now arranged in the order of frequency of use, so that you can access to the desired item more easily.

The following show the initial Setup menu screens and the menu item orders before and after V2.20.

Note that the description of the Setup menu operation in the PD-6 operation manual is based on the earlier version, therefore, there are some differences between the actual operations with V2.20 and the manual description.

<Primary Setup screen before V2.20>

```

SETUP▶
▼Select drive▶
  AutoCopy :Off
  Adjust RTC▶
  Digital out:AES/EBU
  Digital in▶
  Skip mode: File
    
```

<Primary Setup screen after V2.20>

```

SETUP▶
▼Select drive▶
  Default file name▶
  Default track name▶
  Next event No:00001
  Limiter parameter▶
  AutoCopy :Off
    
```

<Menu item order before V2.20>

```

Diagnoses: On
Ref.level: -20dB
Peak hold: 3sec
Tone rec mode▶
Auto cue: Off
Pause time: 0.2min
Error tone▶
BATT warning:10.5V
Speaker mute: Off
Limiter parameter▶
Default file name▶
Default track name▶
Next event No:00001
Keyboard: US
Pre rec time: 10sec
Max File Length:2G
Save user setup▶
Load user setup▶
Version▶
    
```

<Menu item order after V2.20>

```

Digital out:AES/EBU
Digital in▶
Skip mode: File
Diagnoses: On
Ref.level: -20dB
Peak hold: 3sec
Tone rec mode▶
Auto cue: Off
Pause time: 0.2min
Error tone▶
BATT warning:10.5V
Speaker mute: Off
Keyboard: US
Pre rec time: 10sec
Max File Length:2G
False Start:Rename
Chain Play: Off
Adjust RTC▶
Save user setup▶
Load user setup▶
Version▶
    
```

Enhancement of the "Default file name" menu item in the Setup menu

The "Default file name" menu item in the Setup menu is enhanced by adding the "Reel mode" option to the default file name mode. Therefore, there are now three options for file name mode selection: "Date", "Scene name + Take No." and "Reel No. + File No.".

See also "Default file name setting (Default file name)" on page 99 in the PD-6 operation manual.

Press the [SETUP] key to enter the Setup menu, and use the [SEL] dial to select the "Default file name", then press the [ENTER] key.

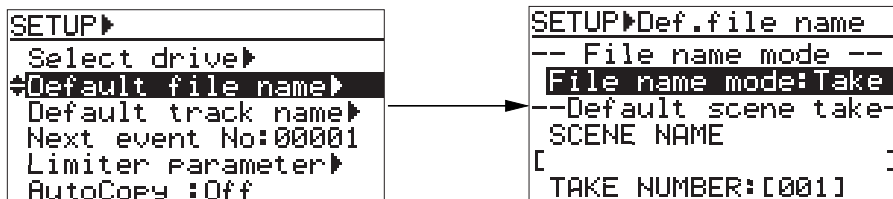

• Setting the file name mode

By pressing the [ENTER] key when the screen above right is shown, the currently selected mode starts flashing and you can now select the desired mode (the default mode is "Take").

Use the [SEL] dial to select the desired mode and press the [ENTER] key to confirm your selection.

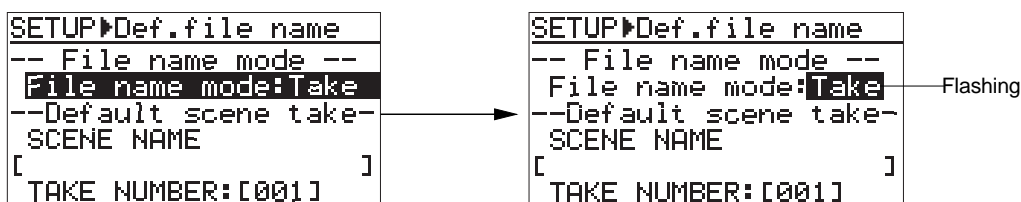

Take (Default)	"<SCENE NAME>_<TAKE NUMBER>.wav" is the default file name. The SCENE NAME is specified on the same screen above. The TAKE NUMBER is incremented automatically each time recording is made. Example: Last_Scene -001.wav, Last_Scene -002.wav, etc.
Date	The internal realtime clock data (with ".wav", the file extension) is the default file name. That is, a file name shows the recording date/time information. Example: B05h 05m 06s 10may 2004.wav, etc.
Reel	The reel number of a drive (or a partition of the optional hard disk drive) currently selected for recording with the file number is the default file name. Example: S001_005.wav, S002_008.wav, etc.

* After recording is made, the default file name can be edited using the "Edit file name" menu item in the UTILITY menu.

When setting the file name mode to "Take", the SCENE NAME and TAKE NUMBER specified on the same screen are used for each file name. Even if you set the file name to "Date" or "Reel", the SCENE NAME and TAKE NUMBER currently set are used as the SCENE data in the meta data.

"False Start" menu item newly added to the Setup menu

The new "False Start" menu item added to the Setup menu.

With the earlier version, if you have made recording unsuccessfully, you can cancel the recording and clear (delete) the audio file by executing "False start" (see page 68 in the PD-6 operation manual).

With V2.20, you have a choice of keeping or completely deleting the audio file when executing "False start" by setting the "False Start" menu item newly added to the Setup menu appropriately.

The following shows how to set the False start mode.

- 1) **While the unit is stopped, press the [SETUP] key to enter the Setup menu.**

The display now shows the Setup menu screen.

```

SETUP▶
*Select drive▶
  Default file name▶
  Default track name▶
  Next event No:00001
  Limiter parameter▶
  AutoCopy :Off
    
```

- 2) **Use the [SEL] dial to highlight "False Start" and press the [ENTER] key.**

The currently selected mode starts flashing (by default, "Rename" is selected).

You can now select the desired mode.

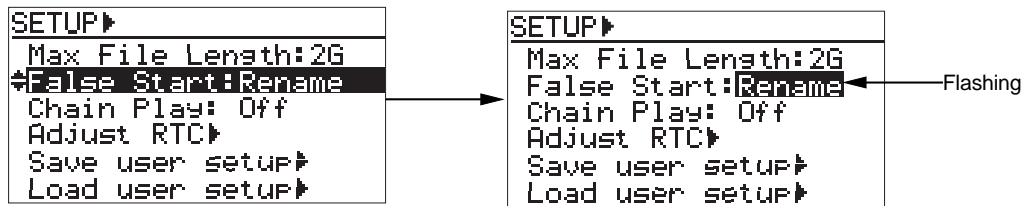

- 3) **Use the [SEL] dial to select the desired mode and press the [ENTER] key.**

You can select between "Rename" (default) and "Delete".

Rename (Default)	<p>When the False start function is executed, the take number decreases by one (i.e. returns to the previous take number) and the canceled audio file is stored as a file with the file name starting by "~nn" followed by the original name ("nn" shows the number). Up to 100 canceled files (starting by ~, ~1 through ~99) can be stored. The following examples show how the file names are given.</p> <p><Examples></p> <p>After the first False start: Scene1_001.wav -> ~Scene1_001.wav</p> <p>After the second False start: Scene1_001.wav -> ~1Scene1_001.wav</p> <p>After the 100th False start: Scene1_001.wav -> ~99Scene1_001.wav</p> <p>You can check stored files from the file selection screen (which can be shown by pressing the [FILE SEL] key).</p>
Delete	<p>As with the earlier version, after executing the False start function, the unsuccessful file is completely deleted and the disk remaining time returns to the value before the last recording is made. The take number decreases by one (returns to the previous take number).</p>

- 4) **After making selection, press the [EXIT] key to exit the Setup menu.**

<Note>: To execute False start, while the unit is stopped, press the [STANDBY] key while holding down the [CLEAR] key. See page 68 in the PD-6 operation manual.

"Chain Play" menu item newly added to the Setup menu

The new "Chain play" menu item added to the Setup menu allows you to set the transport mode after an audio file is played back to the end.

With the older version, the PD-6 stops when an audio file is played back to the end. With V2.20, the PD-6 can also pause at the beginning of the next audio file when an audio file is played back to the end, or play back all audio files on the current disk (or partition when the optional hard disk drive is installed) continuously in the numeric order of file numbers.

The following shows how to select the desired chain play option.

<Note>: All audio files on the current drive (a DVD-RAM disk or partition when the optional hard disk drive is installed), regardless of the recording mode, Fs, etc., are the targets of the chain play function.

- 1) **While the unit is stopped, press the [SETUP] key to enter the Setup menu.**
The display now shows the Setup menu screen.

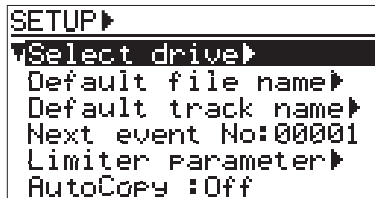

- 2) **Use the [SEL] dial to highlight "Chain Play" and press the [ENTER] key.**
The currently selected mode starts flashing (by default, "Off" is selected).
You can now select the desired mode.

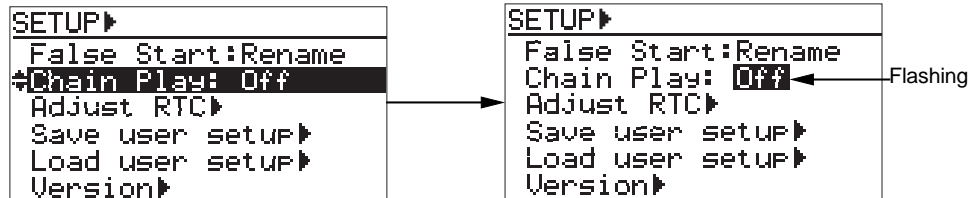

- 3) **Use the [SEL] dial to select the desired mode and press the [ENTER] key.**
The following three modes are available.

Off (Default)	The unit stops when an audio file is played back to the end.
Pause	The unit pauses at the beginning of the next audio file when an audio file is played back to the end.
AutoPly	The unit continuously plays back all audio files following the current file on the current disk (or partition) in the numerical order. When the unit plays back the last file to the end, it stops.

- 4) **After making selection, press the [EXIT] key to exit the Setup menu.**

Changes in the "Set Gen.TC" menu item of the TC SETUP menu

When the time code "Gen mode" is set to "Free Run", the "Set Gen.TC" menu item now allows you to jam the internal realtime clock time data, as well as edit the TC value.

Also, the user bit setting item which was available in the "Set Gen.TC" menu item with the earlier version has been now deleted from this menu item and moved to the newly added "Set Gen Ubit" menu item in the TC SETUP menu. For details about user bit setting, see the explanation of the "Set Gen Ubit" menu item on the next page.

The following explains "Set Gen.TC" menu item setting when the "Gen mode" menu item in the TC SETUP menu is set to "Free Run".

See also the V2.00 supplementary manual for "Set Gen.TC" menu item setting when the "Gen mode" is set to any option other than "Free Run".

While the [SHIFT] indicator is lit, press the [CONTRAST/TC SETUP] key to enter the TC SETUP menu. Then use the [SEL] dial to highlight "Set Gen. TC" and press the [ENTER] key.

The display now shows the "Set Gen. TC" screen on which you can see the generator time code value in realtime.

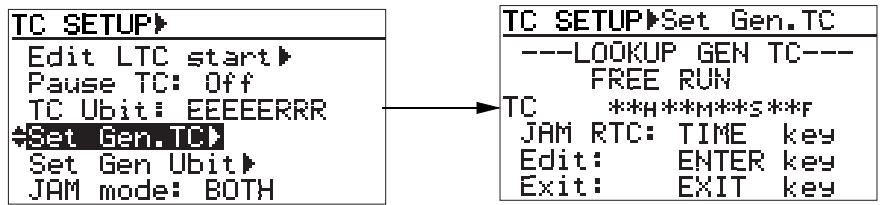

• **Editing the generator time code value:**

While this screen is shown, press the [ENTER] key.

The frame field starts flashing and you can now edit the displayed time code.

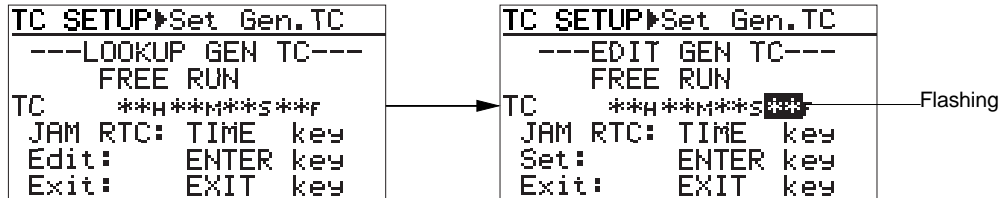

Editing to the desired time value:

Use the numeric keys (or the [SEL] dial) to enter the desired value in the flashing field.

Use the [SKIP/CURSOR] keys to move the flashing field.

After completing entry of the desired time code value, press the [ENTER] key to confirm your entry.

Jamming to the realtime clock:

If you press the [TIME] key, the internal realtime clock time value is set to the generator time code value.

Immediately after editing to the desired time code and confirming the setting, or jamming to the realtime clock, the display changes to the "LOOK UP GEN TC" screen.

"Set Gen Ubit" menu item newly added to the TC SETUP menu

The "Set Gen Ubit" menu item is newly added to the TC SETUP menu. This menu item allows you to set the TC user bit mode and TC user bit value.

While the [SHIFT] indicator is lit, press the [CONTRAST/TC SETUP] key to enter the TC SETUP menu. Then use the [SEL] dial to highlight "Set Gen Ubit" and press the [ENTER] key.

The display now shows the "Set Gen Ubit" screen on which you can set the user bit mode and the user bit value.

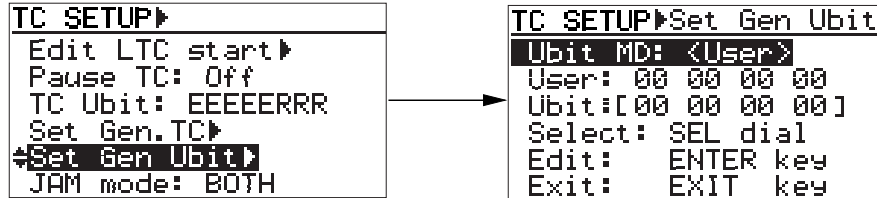

Shows the current user bit. You can set the desired user bit. The rightmost two figures of the user bit are always used regardless of the "Ubit MD" setting.

```
TC SETUP>Set Gen Ubit
Ubit MD: <User>
User: 00 00 00 00
Ubit:[00 00 00 00]
Select: SEL dial
Edit: ENTER key
Exit: EXIT key
```

Sets the user bit mode. See the table below for details about the available options. The default is "<User>", which is set to "00 00 00 00" by default.

Shows the user bit being output according to the current user bit mode. If you change the user bit mode.

Selecting the user bit mode

By pressing the [ENTER] key while "Ubit MD: <User>" is highlighted, the current user bit mode starts flashing and you can now select the mode (by default, "<User>" flashes).

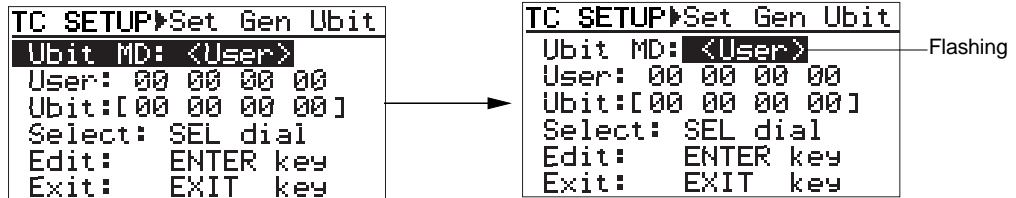

Use the [SEL] dial to select the user bit mode and press the [ENTER] key to confirm your selection. You can select from among the following.

<User>	The default is "00 00 00 00".
MMDDYYuu	BG_76: MM (month) / BG_54: DD (day) / BG_32: YY (year) /BG_10: uu (for USA)
DDMMYYuu	BG_76: DD (day) / BG_54: MM (month) / BG_32: YY (year) /BG_10: uu (for EUR)

When selecting "MMDDYYuu" or "DDMMYYuu", you can set the desired user bit to "uu" of "BG_10: uu". The other fields are automatically set to the date of the realtime clock.

Editing the user bit

By using the [SEL] dial to highlight "User: 00 00 00 00" and pressing the [ENTER] key, the rightmost field of the current user bit (by default, "0") starts flashing and you can now make editing. You can enter the desired value to the flashing field using the numeric keys or the [SEL] dial (or a USB keyboard). You can move the flashing field using the [SKIP/CURSOR] key.

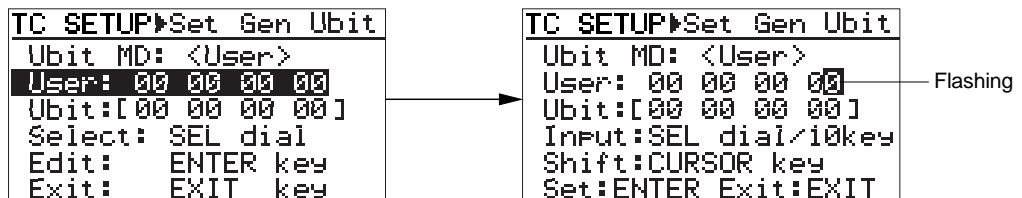

Enhancement of the "Format" menu item in the UTILITY menu

The "Format" menu item is used for formatting a DVD-RAM disk set to the PD-6 or the optional EX-12, or a partition of the optional internal hard disk or the optional EX-12. In this menu item, the following three changes has been made.

- **You can now select on or off of the physical format when "Mirror" is selected as the Format mode.**

With the earlier software version, you can select on or off of the physical format only when "Normal" is selected as the Format mode. With the new version, you can select on or off of the physical format even when "Mirror" is selected as the Format mode.

Note that you can select the "Mirror" mode when formatting a partition of the optional hard disk, a DVD-RAM disk on the optional EX-12 or a partition of the EX-12 (you cannot format a DVD-RAM disk on the PD-6 in the "Mirror" mode).

<Note>: It takes a long time to execute the physical format. We recommend executing the physical format when disk access time becomes longer or sound interruption occurs in normal use. You do not need to physical-format a brand-new or relatively new disk. However, regardless of whether the format mode is "Normal" or "Mirror", there may be a case that "Physical Format" on the Format screen is automatically set to "On" and you cannot select "Off". In this case, the unit decides that the disk to be formatted needs the physical format and you must execute the physical format.

<Note>: Do not turn off the power of the unit while executing the physical format.

- **The default "Format Mode" in the Format menu item has been changed.**

With the earlier version, when reformatting a DVD-RAM disk (or a partition of the optional hard disk), "Format Mode" in the Format menu item always shows "Normal" by default.

With the new version, the current format mode of the disk (or partition) is shown.

For example, if you are going to format a partition of the optional hard disk which was formatted by the "Mirror" mode last time, "Mirror" is shown. You can change the setting when executing formatting.

You can, of course, select the desired format mode before formatting a disk (or partition).

- **After formatting completes, the formatted drive is selected as the current drive.**

With the earlier software version, if you format a partition of the optional hard disk while the DVD-RAM drive is selected as the current drive, the DVD-RAM drive is still selected as the current drive after formatting completes. With the new version, the formatted partition is selected as the current drive after formatting completes.

<Note>: If you format a DVD-RAM disk while a hard disk partition is selected as the current drive, the DVD-RAM is not selected as the current partition after formatting completes. In other words, only when you format a partition of the optional hard disk while the DVD-RAM drive is selected as the current drive, the current drive changes after formatting completes.

See also the operation manual and the V2.0 supplement for details about formatting.

Change in the "Pull Up/Down" function

With the earlier version, the TC frame rate always changes in sync with +/- 0.1% speed change. With the new version, the TC frame rate does not always change, as shown in the table below.

[FRAME] SW setting	0%	+0.1%	-0.1%	
23.976	23.97 FPS	24 FPS	23.97 FPS	The TC frame changes only when the clock is pulled up.
24	24 FPS	24 FPS	23.97 FPS	The TC frame changes only when the clock is pulled down.
25	25 FPS	25.025FPS	24.97 FPS	The TC frame changes when the clock is pulled up or down.
29.97DF / ND	29.97 FPS	30 FPS	29.97 FPS	The TC frame changes only when the clock is pulled up.
30DF / ND	30 FPS	30 FPS	29.976	The TC frame changes only when the clock is pulled down.

Enhanced USB keyboard operation

The capability for controlling the PD-6 from a USB keyboard connected to the [USB] port is enhanced.

The functions indicated by the arrow in the table below are newly added.

Function keys

F1 key	Selects the "Edit file name" menu item in the Utility menu.
F2 key	Acts the same as the [CIRCLE TAKE] key on the panel.
F3 key	Selects the "Default file name" menu item in the Setup menu.
F4 key	Selects the "Default track name" menu item in the Setup menu.
F5 key	Selects the "Set Gen. TC" menu item in the TC Setup menu.
→ SHIFT key + F6 key	Brings up the False start execution screen.
SHIFT key + F7 key	Selects the "Format" menu item in the Setup menu.

Shortcuts

ALT key + F key	Acts the same as the [FILE SEL] key on the panel.
→ ALT key + D key	Selects the "Select drive" menu item in the Setup menu.
ALT key + C key	Acts the same as the [CUE] key on the panel.
ALT key + S key	Enters the Setup mode.
ALT key + U key	Enters the Utility mode.
ALT key + L key	
ALT key + E key	Enters the EDL SEL mode.
ALT key + T key	Enters the TC Setup mode.

Other keys

Right/Left/Down/Up key	These keys can be used to enter characters or move the cursor position when editing the name for a label or file name.
ESC key	Acts the same as the [EXIT] key on the panel.
ENTER key	Acts the same as the [ENTER] key on the panel.
BS key	Executes the back space function for character entry.
DEL key	Executes the delete function for character entry.
→ HOME key	Returns to the Home screen directly.

Control key

→ Ctrl key + L key	Acts the same as the [LOCATE] key on the panel.
---------------------------	-------------------------------------------------

Fostex

FOSTEX CO.

3-2-35, Musashino, Akishima-shi, Tokyo, Japan 196-0021

FOSTEX AMERICA

15431, Blackburn Ave., Norwalk, CA 90650, U. S. A.