

# FE126E

## Unique Back Loaded Horn + Bass Reflex Hybrid Enclosure

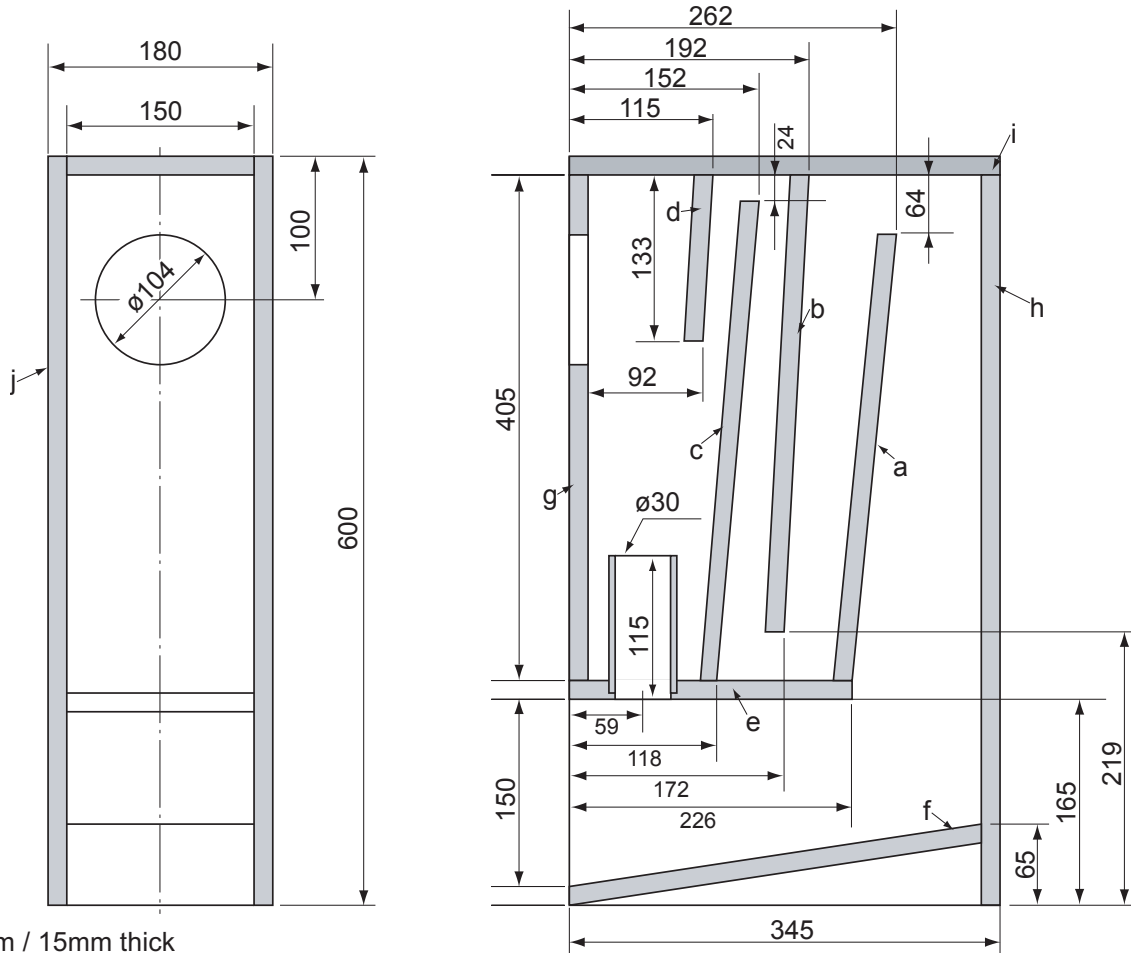

unit:mm / 15mm thick

- Shown is an example of a FE126E back loaded horn + bass reflex hybrid enclosure.
- Horn frequency is tuned at 100Hz and bass reflex 'Fb' at 55Hz.
- Employing the bass reflex port in the back cavity, this setting realizes the extended low frequency while the dip with the characteristic of back loaded horn is reduced.

unit:mm / 15mm thick

	Width	Length	QTY
a	150	343	2
b	150	367	2
c	150	383	2
d	150	135	2
e	150	226	2
f	150	349	2
g	150	405	2
h	150	585	2
i	150	345	2
j	345	600	4

\*Listed boards are for a pair.

\*Listed length is including cut part.

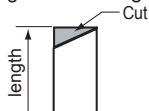

### Recommended Standard Bass Reflex Type Enclosure

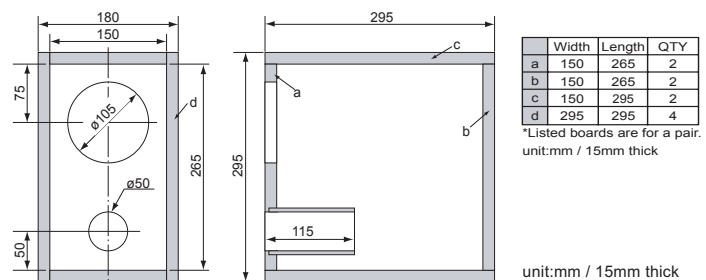

	Width	Length	QTY
a	150	265	2
b	150	265	2
c	150	295	2
d	295	295	4

\*Listed boards are for a pair.  
unit:mm / 15mm thick

unit:mm / 15mm thick

Example of FE126E standard bass reflex type enclosure. Internal volume is 10.5 liters tuned to approximately 61Hz (Fb).